

Mecmesin

testing to perfection

Helixa-i Precision Torque Testing System



Child-Resistant
Closures



Syringe
fittings



Bearings



Lipsticks



Torsion Springs



Dosage Delivery
Devices

Helixa-í Overview

Mecmesin's Helixa torque tester provides the ideal solution for measuring low and medium torque variations on a variety of delicate or finely-engineered products. Its sensitivity and precise alignment make it suitable for testing high quality assemblies such as those found in the cosmetics, jewellery, electronics, pharmaceutical and medical industries.

Why choose Mecmesin?

Mecmesin has been designing, manufacturing and supplying precision force and torque testing systems and instruments for over 35 years. The full range of Mecmesin torque testing equipment includes simple hand-held sensors and displays right through to PC-controlled test stands driven by powerful control and acquisition software.

With an unrivalled network of distributors in over 50 countries, we are able to provide local technical expertise with full training and after-sales support.

precision
accuracy
repeatability

Interchangeable intelligent torque cells

Helixa torque cells (HTC) are quick and easy to fit to the Helixa test frame.

The capacity and calibration details of the individual torque cell are auto-detected by the Emperor control software, ensuring that set-up and use of the system is simplicity itself.

Choose from a range of 7 different HTC torque cells allowing you to measure from a few mN.m up to 6 N.m with an unrivalled accuracy of $\pm 0.5\%$ of full scale.

Each HTC is supplied complete with a calibration certificate, traceable to national standards.



Helixa-i

Key features

control
versatile
complete

Counterbalance for eliminating the weight of a grip being applied to a sample. Significant when testing precise torque at low forces

Load tray for applying a predefined axial load e.g. when push-off twist testing child-resistant closures



Protective bellows prevents ingress

Interchangeable Helixa torque cell (HTC). Quick and easy to fit. Models from 0.1 N.m to 6 N.m capacity

Precision fixtures for securing even the lightest samples. Custom fixtures also available

Easy positioning crosshead for quick adjustment and locking when changing test sample

Precision alignment with torque cell for optimum accuracy, and repeatability, adjustable to each fixture combination. Essential when testing at extremely low torque

High quality construction Manufactured under ISO 9001 quality standards with a two-year warranty and CE declaration of conformity

Emergency Stop Button for safety and compliance

Controlled by Mecmesin's powerful Emperor™ software. Comprehensive programming and results analysis to suit your test requirements

LED power indication
Fused mains power inlet at back with on/off rocker switch

Direction control keys for quick orientation of sample

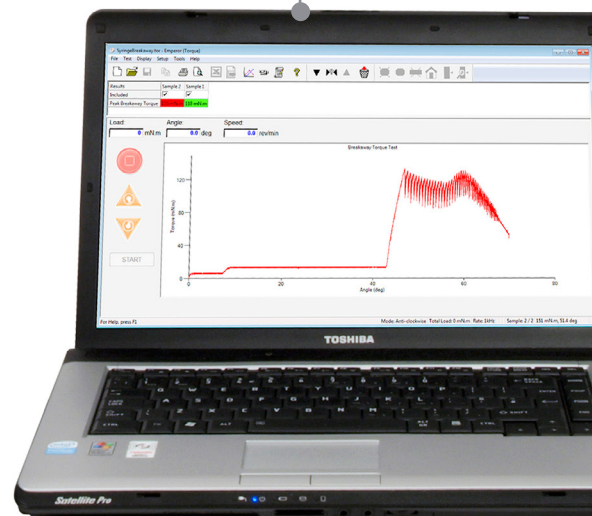

* PC not supplied

The Power of Emperor™

Emperor™ Software has been specifically designed to work with Mecmesin test frames for ultimate test performance. It combines ease of use with powerful programming tools, making it equally suitable for simple, routine analysis in the QC laboratory and sophisticated test routines in the design department. Emperor™ controls the entire test sequence, acquires the data measurement, performs calculations, returns and reports results.

Flexible – Choice of 2 Program Modes

Console Testing Mode

The Console Testing Mode is designed for ease-of-use by operators on the production floor, ideal for repetitive, routine testing.

- **Easy-to-use with minimal training** - ‘Simplicity itself’ one button launches the test
- **Fast access to 5 favourite tests** - customised icons ensure instant test selection

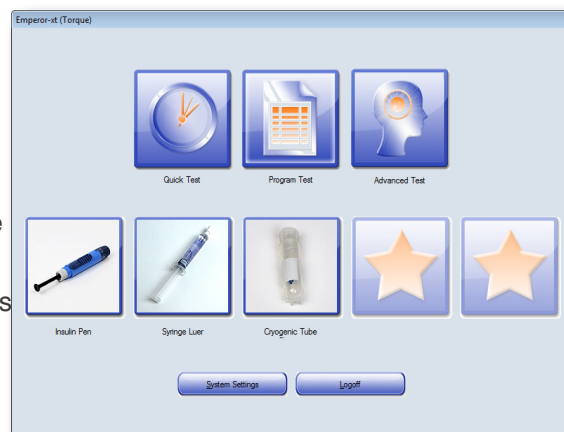

Program Testing Mode

Using the Program Testing Mode, the true power of Emperor™ software becomes evident. This mode has an intuitive interface, which makes the whole test process easy to manage:

- Setting-up the test method
- Running the test
- Making a test report
- Storing & exporting data

With Emperor™ software's comprehensive programming and calculation commands, it becomes a simple task to create customised test programs to evaluate the mechanical strength of components, products and materials.

Toolbars simplify testing by helping operators navigate efficiently to key features.



Creating a Program

Using Emperor™ you can create basic tests through to sophisticated cyclic, event-triggered and conditional programs

- **Design & tailor** your torque test to your **precise needs**
- **Intuitive, easy-to-learn** user interface
- **Create pass/fail criteria** for test samples

The test creation wizard is extremely user-friendly, with fully comprehensive commands to control the Helixa from test start to finish. Full parameters of measurement, including data acquisition rate and system behaviour, are set and saved with each test program.

Performing a Test

- Select from a **library of test procedures**
- Samples & operators can be **tagged for traceability**
- Restricted levels of access between supervisor and operator **avoids accidental tampering with test programs**
- **Toolbars allow quick access** to commonly-used functions

Digital I/O ports can be used to start, pause or stop a sequence, enabling tests to be semi-automated. An external 'event input' is also available to detect the torque/angle at which an electrical connection is made or broken, particularly useful when testing rotary switches.

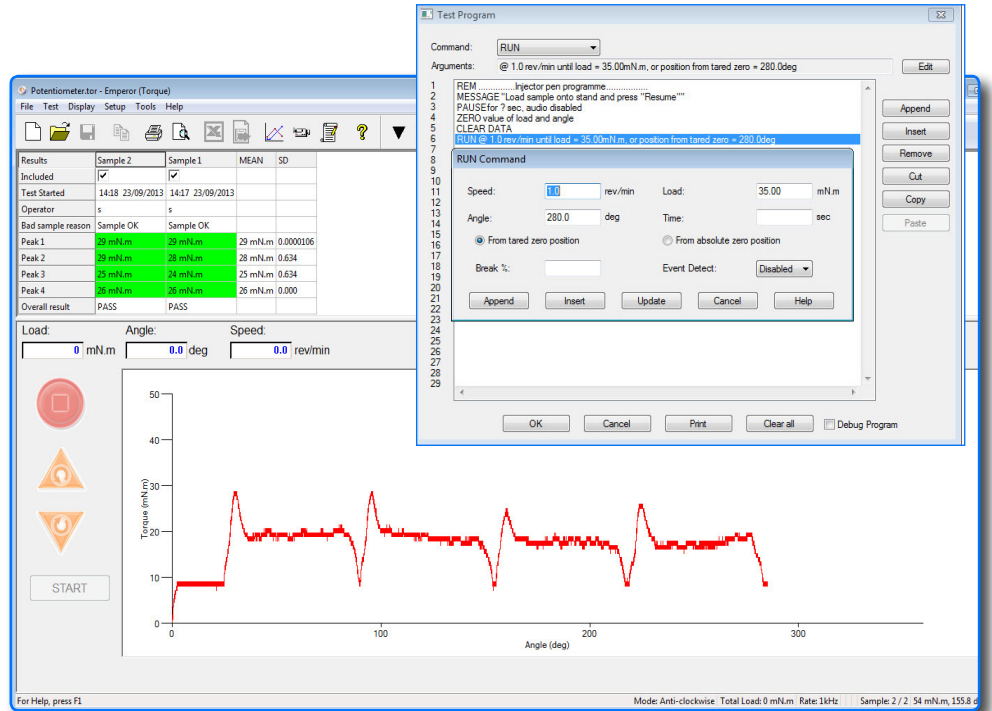

Data Analysis

Examine measurement data by using a wide range of calculations within Emperor™ to report test results. Detect and evaluate sample characteristics and compare against tolerance criteria for acceptability.

- Extensive range of **user-definable calculations**
- **Easy-to-read, comprehensive** display of test results with **colour-coded Pass/Fail notification**
- **Real-time graphs** with overlays in multiple colours and legends
- Simple print function provides an **instant record**
- **Video replay facility** to help identify critical points. Ideal for post-test analysis of product and component testing

Samples can be viewed and analysed individually or as a batch. For more sophisticated R&D analysis new calculations can be added to identify material characteristics.

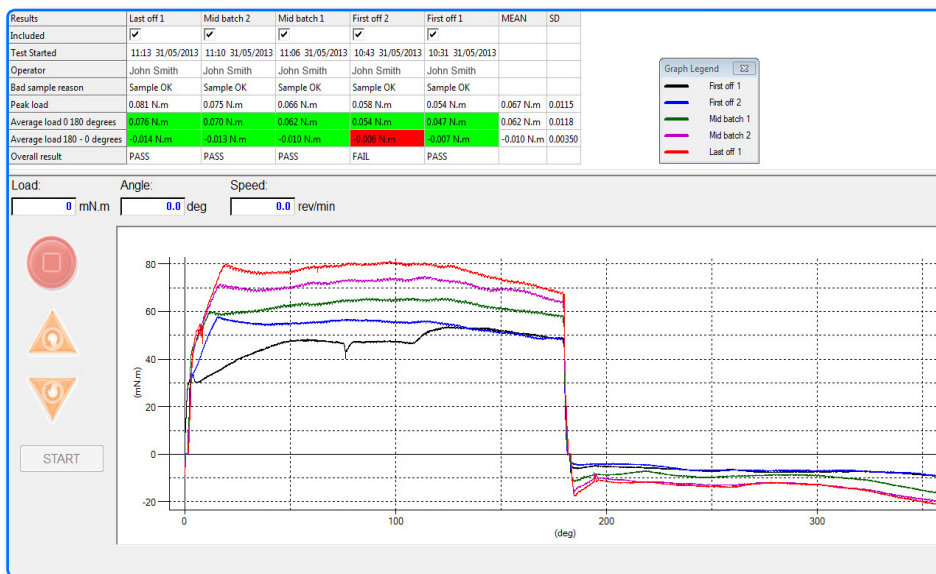

Traces of five Luer lock samples: one shows a test failure

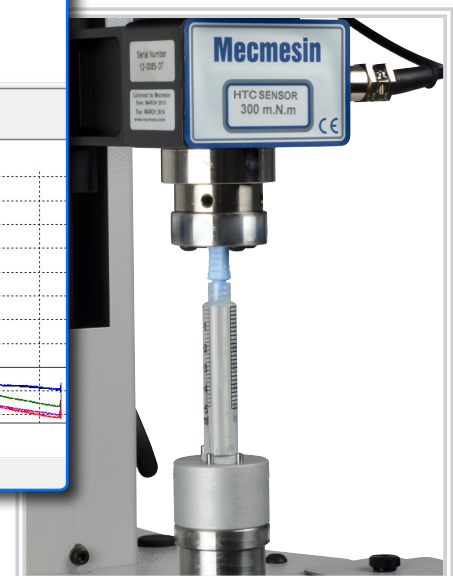

Reports & Exporting

- **Automatic export of data** to Microsoft Excel® and SPC packages
- **Select standard reports** or **create your own** customised templates
- Use 'Print PDF' icon to **create quick PDF report**
- **Collect data at 1000 times per second** for detailed records and results with every sample

Insert your company logo in every report

Customise reports with image of test sample

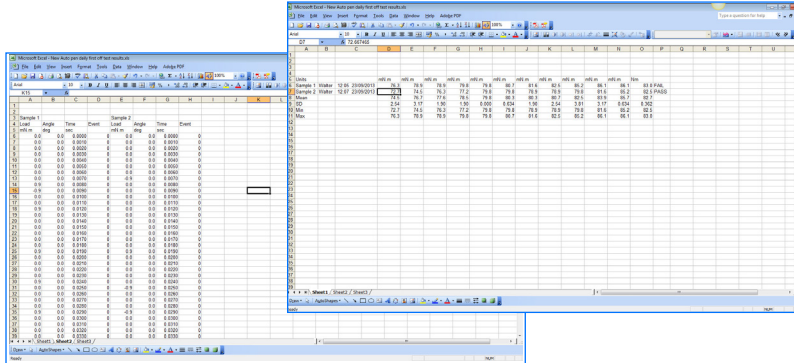

Applications

The Helixa is designed for precision torque applications, where torque forces may be very small and where accuracy is paramount.

A selection of applications include:

- Precision bearings
- Cosmetics containers (e.g. lipstick barrels)
- Medical devices (e.g. Luer fittings and dosage devices)
- Light torsion springs
- Rotary electronics controls and components
- Watch components

Luer lock connectors

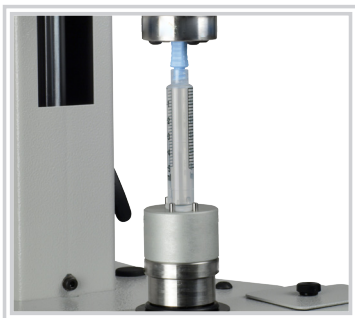

Cosmetics packaging



Watch components

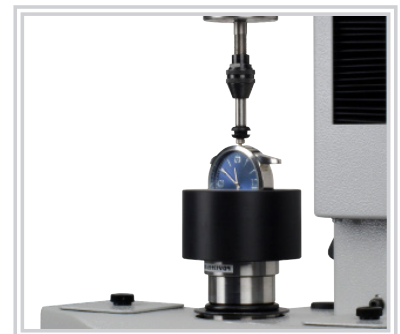

Precision medical devices

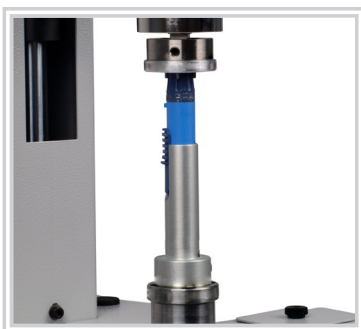

Rotary electronic components and controls

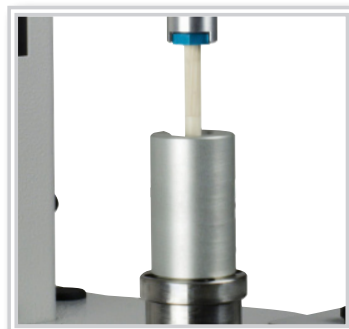

Light torsion springs

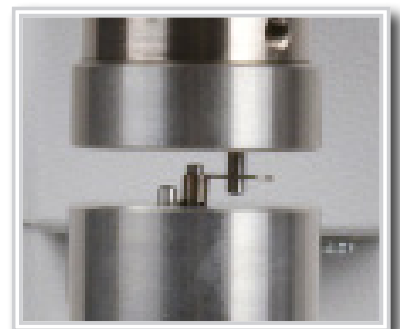

Helixa-xt Console-controlled version

Unlike the Helixa-*i* controlled by a separate PC, the Helixa-*xt* is fitted with a touch-screen console for full measurement control



Helixa-xt

Features and Benefits

Where throughput and ease-of-use are paramount, it combines precision with the simplicity and convenience afforded by a touch-screen display.

- 1 Single button program selection for running your 5 most popular tests
- 2 Compact size takes up minimal space in lab.
- 3 Ideal for repeated, routine testing
- 4 Rapid throughput saves time and money
- 5 Security settings to limit user access for 'master' or 'operator' use

Quick Test

Run an elementary test without having to create a full program

Program Test

Select from a library of standard programs with load and position control

Advanced Test

Upgrade to full programming capability to create and run sophisticated test routines



Ergonomic Design

Adjustable console, pivots and tilts for comfortable use and easy viewing

USB Ports

Connection to networks, memory stick, printers and other USB devices

5 'Favourites'

Customised icons aid selection of your 5 'favourite' tests

Standards

Whether testing using international standards and methods, or against your own design standards, the accuracy and repeatability of the Helixa will always give you reliable results.

control
versatile
complete

The Helixa is an ideal tester for assessing new product development against specification. Its precision alignment adjustment for specific fixtures and samples will give reliable and repeatable testing. The Emperor™ test control and analysis software is powerful and flexible enough for everything from simple single-turn events through to sophisticated and cyclic test profiles under defined axial load.

The Helixa is also the perfect solution for standard methods where axial force is also applied, such as in security closures.

Frequently, it is not just a peak torque or event that is required, but a full and detailed extended profile. The precision of the Helixa combined with the Emperor™ data presentation can fully characterise the torque and friction in the rotation of parts.



Typical Standards

- BS EN 1707 / ISO 594 (ISO 80369): Conical fittings with a 6% (Luer) taper for syringes, needles and certain other medical equipment. Slip and lock fittings
- ISO 11608: Needle-based injection systems for medical use
- ASTM D3810: Minimum application torque of type IA child-resistant closures
- ASTM D3968: Monitoring of rotational torque of type IIIA child-resistant closures
- ASTM D3198: Application and removal torque of threaded or lug-style closures

... and many more

Accessories

Mecmesin engineers have many years experience in designing and manufacturing custom-built fixtures and can provide you with a bespoke solution for the Helixa.

custom
bespoke
accurate

Standard Accessories

The Helixa has a set of standard accessories for testing straightforward applications

(to be ordered separately):



- Upper Plate
- Lower Plate
- V-jaws
- Lightweight Chuck
- Self-centring Vice
- X-Y Positioning Stage



Helixa mounting plate

Threaded holes allow fitting of sample holding fixtures

Upper Plate = part no: 432-601

Lower Plate = part no: 432-600



* shown with V-shape jaws
part no: 432-602

Custom Accessories

In most situations the Helixa will be used on smaller and precision-engineered components that cannot be held in standard fixtures due to their unique form.

Concentricity in a torque test is only as good as the least precisely-held part. Plastics components especially must be carefully fixtured to prevent distortion by the grip.

Whilst we can supply a wide range of standard fixtures, for precision torque testing it is likely that you will require customised fixtures. At Mecmesin we have experienced engineers who can work with you to design and manufacture custom solutions specifically for your applications, or integrate fixtures you already have.

The examples shown below are representative of our capability, showing upper and lower fixtures for specific products.



Luer lock fixture



Torsion spring fixture



Specifications

| TORQUE TRANSDUCER (HTC) RANGE | 0.1 N.m | 0.2 N.m | 0.3 N.m | 1.0 N.m | 1.5 N.m | 3.0 N.m | 6.0 N.m |
|--|---|---------|---------|---------|----------|----------|----------|
| N.m | 0 - 0.1 | 0 - 0.2 | 0 - 0.3 | 0 - 1.0 | 0 - 1.5 | 0 - 3.0 | 0 - 6.0 |
| kgf.cm | 0 - 1 | 0 - 2 | 0 - 3 | 0 - 10 | 0 - 15 | 0 - 30 | 0 - 60 |
| lbf.in | 0 - 0.9 | 0 - 1.8 | 0 - 2.7 | 0 - 8.9 | 0 - 13.3 | 0 - 26.5 | 0 - 53.1 |
| AXIAL ALIGNMENT | | | | | | | |
| Total runout (without fixtures) | Better than ± 0.25 mm | | | | | | |
| SPEED | | | | | | | |
| Speed range | 0.1 to 30 rev/min (clockwise or anticlockwise) | | | | | | |
| Speed accuracy | $\pm 0.2\%$ of indicated speed | | | | | | |
| Speed resolution | 0.1 rev/min | | | | | | |
| TORQUE MEASUREMENT (USING Emperor™) | | | | | | | |
| Torque accuracy | $\pm 0.5\%$ of full scale | | | | | | |
| Torque resolution | 1:6500 | | | | | | |
| Torque units display | mN.m, N.cm, N.m, kgf.cm, gf.cm, ozf.in, lbf.ft, lbf.in | | | | | | |
| Sampling rate | 1,000 Hz, 500 Hz, 100 Hz, 50 Hz, 10 Hz | | | | | | |
| DISPLACEMENT | | | | | | | |
| Maximum displacement (from tared position) | 2500 revs | | | | | | |
| Displacement accuracy | 0.1° | | | | | | |
| Displacement resolution | 0.2° | | | | | | |
| System resolution | 0.045° | | | | | | |
| DIMENSIONS | | | | | | | |
| Height | 758 mm | | | | | | |
| Width | 290 mm (Helixa-i) | | | | | | |
| | 586 mm (Helixa-xt) | | | | | | |
| Depth | 414 mm (without external weight hanger) | | | | | | |
| | 505 mm (with external weight hanger and weights) | | | | | | |
| Headroom (without fixtures) | 350 mm | | | | | | |
| | 292 mm | | | | | | |
| Crosshead travel | 127 mm (without bellows) | | | | | | |
| Throat depth | 111 mm (with bellows) | | | | | | |
| Weight | 28 kg (Helixa-i) | | | | | | |
| | 32 kg (Helixa-xt) | | | | | | |
| STATIC WEIGHTS (max allowed) | | | | | | | |
| Rear counterbalance | 40 N (maximum) | | | | | | |
| Torque cell mass platen | 60 N (maximum) | | | | | | |
| COMMUNICATIONS | | | | | | | |
| Digital I/O | 6 input, 6 output (TTL) | | | | | | |
| Printer/datalogger outputs, and results file transfer (Helixa-xt only) | RS232 and USB | | | | | | |
| Network communications (Helixa-xt only) | Ethernet RJ45 USB for external wireless connectivity | | | | | | |
| POWER SUPPLY | | | | | | | |
| Maximum input power | 120 W | | | | | | |
| Voltage | 230 V AC 50 Hz, or 110 V AC 60 Hz | | | | | | |
| OPERATING ENVIRONMENT | | | | | | | |
| Recommended temperature range | +10° to +35° C (50° to 95° F) | | | | | | |
| Humidity | Normal industry and laboratory conditions, non condensing | | | | | | |
| NOISE EMISSIONS | | | | | | | |
| Noise emissions | < 70 db (A) Less than 70 db (A) | | | | | | |

Mecmesin reserves the right to alter equipment specifications without prior notice. E&OE

Specifications

Helixa-í

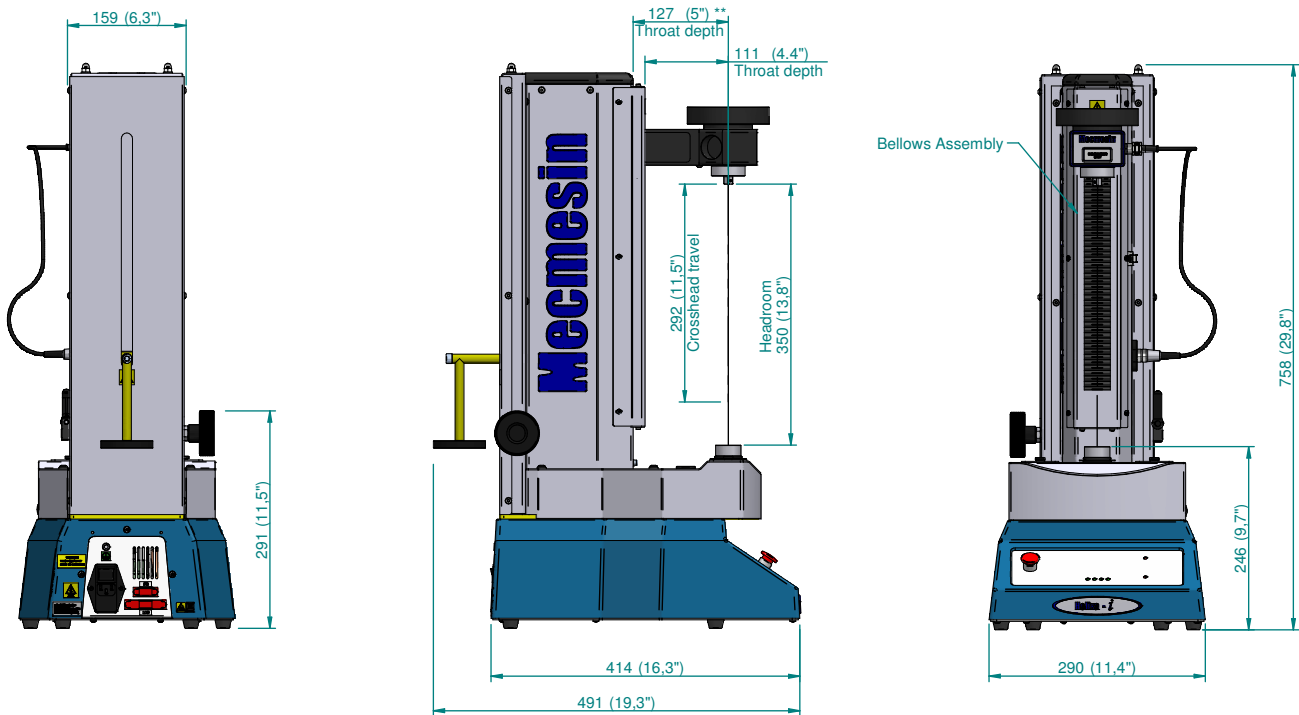

**Note: Throat depth can be increased by removing bellows assembly

Helixa-xt Dimensions

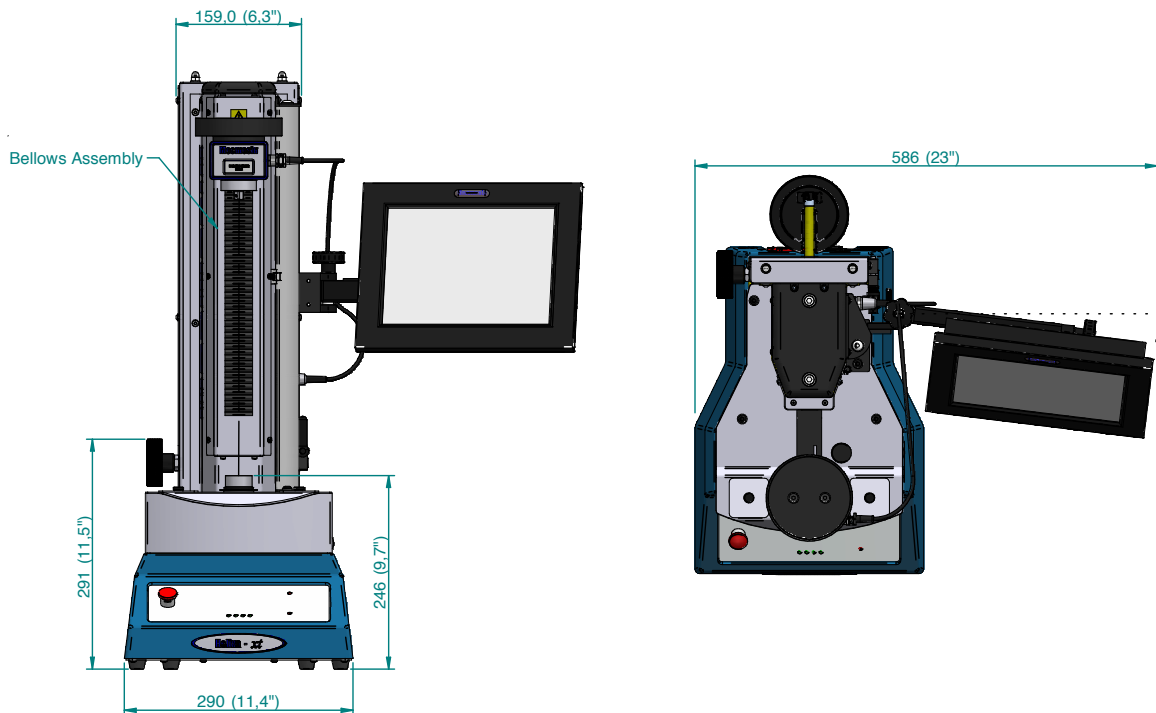

Mecmesin

testing to perfection

Mecmesin - a world leader in affordable force and torque testing solutions

Since 1977, Mecmesin has assisted thousands of companies achieve enhanced quality control in design and production. The Mecmesin brand represents excellence in accuracy, build, service, and value. In production centres and research labs worldwide, designers, engineers, operators, and quality managers endorse Mecmesin force and torque testing systems for their high performance across countless applications.

www.mecmesin.com



| | | |
|----------------|-------------|--------------|
| Algeria | Hungary | Philippines |
| Argentina | India | Poland |
| Australia | Indonesia | Portugal |
| Austria | Iran | Romania |
| Bangladesh | Ireland | Russia |
| Belgium | Israel | Saudi Arabia |
| Brazil | Italy | Serbia |
| Bulgaria | Japan | Singapore |
| Cambodia | Korea | Slovakia |
| Canada | Kosovo | Slovenia |
| Chile | Laos | South Africa |
| China | Latvia | Spain |
| Colombia | Lebanon | Sri Lanka |
| Costa Rica | Lithuania | Sweden |
| Croatia | Macedonia | Switzerland |
| Czech Republic | Malaysia | Syria |
| Denmark | Mexico | Taiwan |
| Ecuador | Morocco | Thailand |
| Egypt | Myanmar | Tunisia |
| Estonia | Netherlands | Turkey |
| Finland | New Zealand | UK |
| France | Norway | Uruguay |
| Germany | Paraguay | USA |
| Greece | Peru | Vietnam |

The Mecmesin global distribution network guarantees your testing solution is rapidly delivered and efficiently serviced, wherever you are.



FS 58553

DISTRIBUTOR STAMP

Mecmesin reserves the right to alter equipment specifications without prior notice.

E&OE

Head Office - UK Mecmesin Limited

w: www.mecmesin.com
e: sales@mecmesin.com

North America Mecmesin Corporation

w: www.mecmesincorp.com
e: info@mecmesincorp.com

France Mecmesin France

w: www.mecmesin.fr
e: contact@mecmesin.fr

Asia Mecmesin Asia Co., Ltd

w: www.mecmesinasia.com
e: sales@mecmesinasia.com

Germany Mecmesin GmbH

w: www.mecmesin.de
e: info@mecmesin.de

China Mecmesin (Shanghai) Pte Ltd

w: www.mecmesin.cn
e: sales@mecmesin.cn